

# The Performance Estimation of the Situation Awareness RFID System from Ubiquitous Environment Scenario

Dongwon Jeong<sup>1</sup>, Heeseo Chae<sup>2</sup>, and Hoh Peter In<sup>2</sup>

<sup>1</sup>Dept. of Informatics & Statistics, Kunsan National University,  
San 68, Miryong-dong, Gunsan, Jeollabuk-do, 573-701, Korea  
djeong@kunsan.ac.kr

<sup>2</sup>Dept. of Computer Science & Engineering, Korea University,  
1, 5-ka, Anam-dong, Sungbuk-ku, Seoul, 136-701, Korea  
{royalhs, comtaek, hoh\_in}@korea.ac.kr

**Abstract.** Many sensors providing situation data will be in everywhere under the ubiquitous environment. It requires the current RFID system should be extended to recognize and use situation information from the sensors. We already proposed a new RFID system architecture that is suitable for the coming ubiquitous environment, and basically consists of the key components such as the inference engine, use policy, and definition language. It has four alternatives (types) depending on the role distributions to the components. This paper shows the performance evaluations of the alternatives. Using the research results, we can select a proper RFID system architecture for corresponding ubiquitous application. The contributions of this paper are as follow: providing a new RFID system architecture to recognize, analyze, and utilize the situation information; defining the four alternatives for ubiquitous applications.

## 1 Introduction

In the ubiquitous computing environment, the computing paradigm as well as our life style will be changed. Some people can get the real-time transportation information that the next bus will arrive soon at the bus stop. Other people are provided seamless movies or high quality games when they move from outdoor with mobile phone to indoor with more efficacious resource like TV, PC, and so on.

Radio Frequency Identification (RFID) system and Situation-Aware (SA) technology are center of these transition. One of the most popular ubiquitous applications is the RFID system. Currently, the RFID system is studying vigorously. The RFID system generally consists of RFID tag, RFID reader and Data Processing Subsystem (DPS). The RFID tag saves information and The RFID reader reads tag information. Then the DPS treats these data and uses the processed information. The RFID system has limitation that this system mostly used to discriminate an individual in limited environment, but it attentions its broad appliance. Especially, the coming ubiquitous environment requires the enhancement of the current RFID system [9].

Situation-Aware (SA) technology supports that devices are able to take actions automatically and timely depending on situation information offered by surrounding

sensor. It is based on the existing sensor-network. However, the SA technology is more aware of situation and its processes are performed intelligently with a variety of information collected by sensors, not at a certain time sequence.

In [9], we defined and proposed a RFID system architecture which has been integrated to conquer the limitations of RFID system over the SA technology. [9] just showed the new RFID system architecture and its system alternatives. For its appli-ance, the differences among the alternatives should be studied. The research result can be used as templates to select proper system architectures for target applications. Most of all, performance efficiency of each system architecture type (alternative) should be considered for actual application. Therefore, this paper focuses on the performance evaluation. With the evaluation result, we can choose the most suitable architecture.

## 2 SA-RFID System Overview

In [9], the SA-RFID system was proposed for the current RFID system to be suitable for the ubiquitous computing environment. The SA-RFID system enhances usability of the current RFID system by use of information acquired from various sensors.

The proposed SA-RFID system is capable of recognizing such a situation and determining the use of the resource based on the recognized situation information. The system architecture is extended from the current RFID system architecture.

[9] distributed the SA-RFID system into four types. The conceptual architecture is illustrated in Fig. 1.

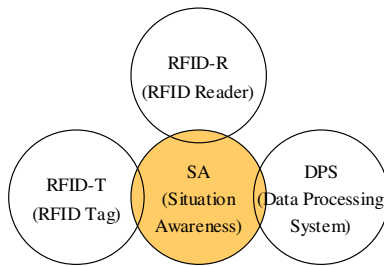

**Fig. 1.** Conceptual architecture of SA-RFID system

In Fig. 1, a RFID tag (RFID-T) holds ID information of an object, and it is the same as the traditional-current RFID-T function. The RFID reader (RFID-R) reads information from the RFID-T. In addition, in case of the SA-RFID system architecture, the RFID-R can provides extended functions that can acquire situation information from sensors, infer proper actions from the situation information, and execute the actions.

The data processing system (DPS) basically utilizes the information acquired by the RFID-R. The DPS also contains information pertaining to the use policies and determines suitable actions by inferring and judging the situation information.

For supporting the SA technology, the RFID system requires functions to collect situation information, define use policies with a profitable representation language, and infer for determining valid actions using the use policies and the situation information collected. We satisfy these requirements by applying the concept of the SA.

Fig. 2 depicts the types of the SA-RFID system architectures classified based on functions for supporting SA (Situation Awareness) concept and related operations [9].

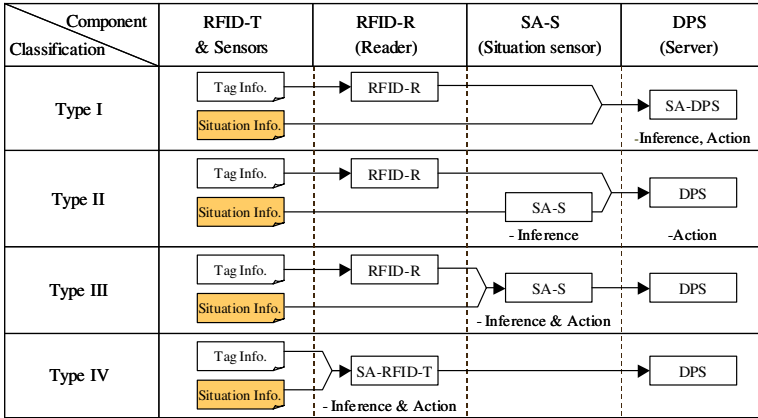

Fig. 2. Classification of SA-RFID system architecture

The architectures are classified based on whether a new component is added into the existing RFID system. In other words, the architectures are grouped into a Non SA-Sensor Based (NSSB) architecture not requiring the new component SA-Sensor and a SA-Sensor Based (SSB) architecture requiring the new component. In the NSSB architecture, the SA inference and execution are processed by the DPS (Type I) or by the RFID-R (Type IV). In the SSB architecture, the situation information is inferred by the SA-Sensor but the execution according to the use policies is processed by the SA-Sensor (Type II) or by the DPS (Type III).

As for Type I which extends the functions of the DPS, the situation information is received directly from the sensors, and the DPS infers the situation information based on the received situation information and tag information acquired from the RFID-R and executes the resulting actions referred with the use policies.

As for Type II, the new component SA-Sensor is added and forwards to the DPS the situation information collected from the sensors. The SA-Sensor infers the situation information from the sensors, and sends the results to the DPS. The DPS obtains the tag information from the RFID-R and the actions from the SA-Sensor, and then executes the actions.

Type III is similar to Type II, the SA-Sensor processes both of the inference and execution depending on the use policies. And the SA-Sensor gets the tag information and sends it to the DPS with the action result.

Finally, Type IV is an extended architecture and the RFID-R performs the functions of the SA-Sensor. Therefore, the RFID-R processes the inference and execution by collecting the situation information from the sensors.

### 3 States and Transition in Architecture Alternatives

*Type I: SA-DPS based system*

The SA-DPS based system has not a concept being dependent of SA part and DPS part but a concept of architecture extended and integrated. This architecture can be realized through easy and simple extension of the existing DPS. However, it is a disadvantage to be delayed in gathering information by remote communication between sensors and the SA-DPS so that reliability could not be assured.

On SA-DPS based system, the RFID-R sends the information came from the RFID-R to SA-DPS and simultaneously sends situation information received from neighbor sensors to the SA-DPS as well. Fig. 3 shows the sequence diagram model of the SA-DPS based RFID system. The sequence diagram model is widely being used for the time-based process design [12].

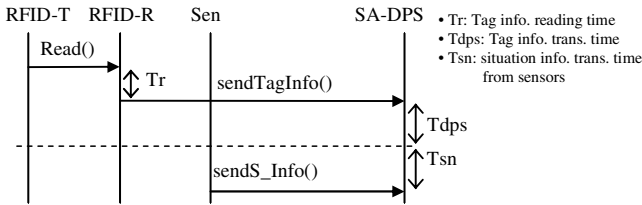

**Fig. 3.** SA-DPS Based RFID System sequence diagram

We assume the data transmission time and processing time is uniform. The architecture’s performance can be evaluated in terms of processing some portion of data by the summation of  $Tdps$ , which is the time that RFID-R spends sending the information to SA-DPS, and the time that gathered information from sensors reaches SA-DPS. The calculation model for the whole processing time of the SA-DPS based RFID system  $T_{SA-DPS}$  is defined as follows:

$$T_{SA-DPS} = Tdps + Tr + Tsn \tag{E1}$$

As you can see a relative gap of delayed time in Fig. 4, the point which we have to pay attention to is that there is an issue for spatial heterogeneousness between sensors gathering situation information and SA-DPS receiving it. Hence, the problem from remote communication between the sensors and SA-DPS can be solved when all of sensors can make it with securing communication reliability.

*Type II: SA-Sensor supplementary system*

The SA-Sensor supplementary RFID system architecture requires an additional sensor SA-S (Situation Aware-Sensor) which plays roles to gather situation information from sensors and send the DPS the acquired situation information. In this architecture type, while the RFID-R sends the tag data came from the RFID-T to the DPS, the SA-sensor sends the information gathered from sensors to the DPS at once with directing them. The tag data and situation information pushed to the DPS help the system make a decision for usage policy and run it. Fig. 4 shows the sequence diagram of this system architecture.

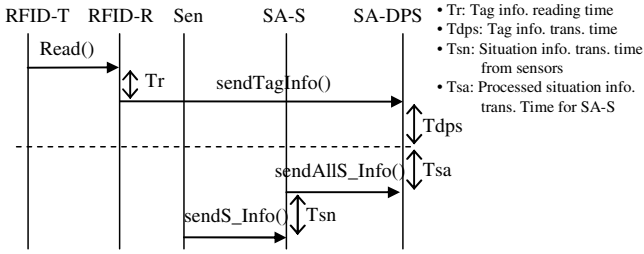

Fig. 4. Sequence diagram for the SA-Sensor supplementary RFID System

We assume that the data transmission time and the data processing time in a terminal machine like other architectures, and particularly there is no difference between each of spending time in sending data from sensor to SA-S and from SA-S to DPS.

Let the whole processing time of the SA-Sensor supplementary RFID system (the processing time and data transmission time) for evaluating performance is  $T_{Supplementary}$ . We can define  $T_{Supplementary}$  as follows:

$$T_{Supplementary} = Tdps + Tr + Tsa + Tsn \tag{E2}$$

Thus, the SA-Sensor supplementary architecture adopted SA-Sensor can improve the reliability of communication between sensors because reading the RFID tag data and gathering situation information from sensors are addressed in same space. Nevertheless, complexity of the architecture is still a problem.

*Type III: SA-Sensor oriented system*

On the SA-Sensor oriented architecture, SA-Sensor plays an intensive role. In the SA-Sensor supplementary system architecture, the SA-Sensor delivers it to the DPS after gathering the information from sensors. However, the strengthened SA-Sensor sends just only processed and inferred situation information to the DPS.

Fig. 5 expresses the sequence diagram for operations of this type. This figure shows sequentially key processing steps in the SA-Sensor oriented RFID system. With this diagram in Fig. 5, we can define the calculation model for estimating the performance of the SA-Sensor oriented RFID system. Let the whole processing time of the SA-Sensor oriented system is  $T_{oriented}$ . Then  $T_{oriented}$  is defined as follows:

$$T_{oriented} = Tsas-r + Tr + Tsa + Tsn \tag{E3}$$

However, in the equation above, the process converting the data came from sensors to situation information is missed, in other words, the data processing time is not considered. In the case of architecture Type I, even though the time for processing situation information is not considered due to system characteristics of the SA-DPS, in the case of SA-Sensor oriented system which has a function for situation inference, a factor explaining data processing time is inserted for accurate performance evaluation. The equation for SA-Sensor oriented RFID system  $T_{oriented}$  can be redefined as follows:

$$T_{oriented} = Tdps + Tr + Tsa + Tsn + Ts-op \tag{E4}$$

Therefore, the SA-Sensor oriented system improved especially in the function of the SA-Sensor makes reliability of information communication increased because of short distance communication between sensors and readers, but lots of resources and computation power are required due to the functions added to the SA-Sensor.

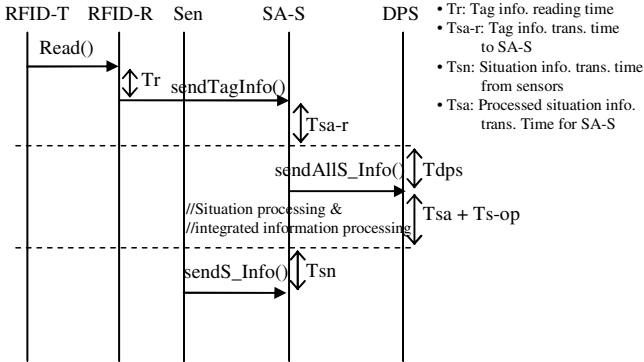

Fig. 5. SA-Sensor Oriented RFID System sequence diagram

Type IV: SA-RFID reader based system

Type IV is an extended architecture especially in terms of reader’s function on other previous architecture. The reader plays a role not only gathering tag data but also gathering raw data from sensors, and also processes the obtained data (including the raw data) and finally sends the processed and integrated situation information to the DPS. We can call the RFID reader having such functions as SA-RFID/SA reader.

This architecture vests the reader in traditional RFID system with the additional functions. It can keep consistency of information management because the behaviors reading tag data and inferring situation information are dealt with in a component at once. It takes little delay time to move on to when considering performance evaluation on SA-RFID reader based system because the architecture of the system has low complexity comparing with other types.

Fig. 6 illustrates the sequential operation steps of this system as a sequence diagram model. According to the diagram, the equation for calculating the performance of this SA-RFID reader based system  $T_{SA-Reader}$  is as follows:

$$T_{SA-Reader} = Tr + Tdps + Tsn \tag{E5}$$

However, overall performance of the system depends on the time consumption factors when reading tag data in the SA-RFID, gathering sensed data, and inferring situation information. Therefore, the above equation can be redefined as follows:

$$T_{SA-Reader} = Tr + Tdps + Tsn + Tr-op \tag{E6}$$

As shown in Fig. 6, in the process moving from the SA-RFID reader to the DPS, inferring situation information and reading tag data are addressed totally through integrating the two kinds of information.

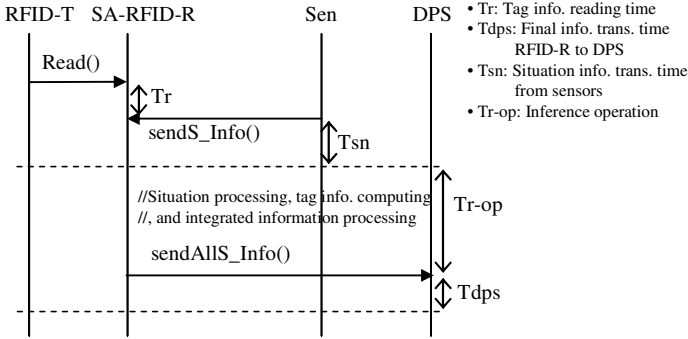

Fig. 6. SA-RFID reader based RFID system architecture

### 4 Evaluations

In this paper, SmartView performance is scenario to which we will pay attention and apply SA-RFID. SmartView is the situation awareness based multimedia contents provider system in ubiquitous environment which provides multimedia data and games for users anytime, anywhere, so users can enjoy various services along with their situation regardless of devices and circumstances [13].

In SmartView scenario, the process gathering tag information plays a role in identifying which device will be provided with service. Table 1 shows the qualitative comparisons between the system architectures.

Table 1. architecture type estimation over the Smartview scenario

|                 | Architecture type I      | Architecture type II       |
|-----------------|--------------------------|----------------------------|
| Tag info        | Identifying platform     | Identifying platform       |
| Situation info. | Providing location info. | Sensing per resource       |
| DPS             | Integrated application   | Application                |
| Delay time      | Most long                | Less than I                |
| Estimation      | Bad                      | Not bad                    |
|                 | Architecture type III    | Architecture type IV       |
| Tag info        | Identifying platform     | Gathering integrated info. |
| Situation info. | Sensing per resource     | Gathering integrated info. |
| DPS             | Application              | Integrating sensed data    |
| Delay time      | Less than I              | Most short                 |
| Estimation      | Good                     | Excellent                  |

Fig. 7 shows the evaluation result with this scenario (These values which are used in estimation are actual value of real system) [10, 11].

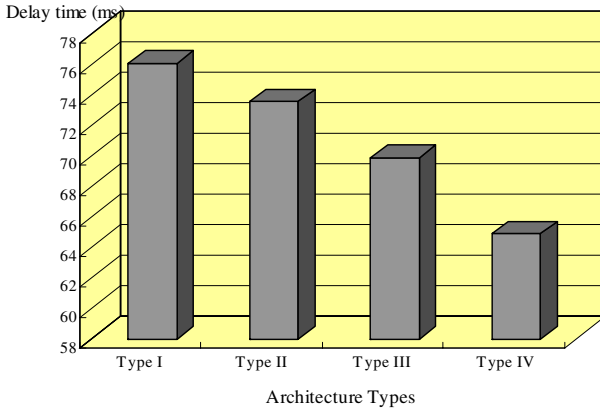

Fig. 7. SmartView Performance Estimation

Consequently, the results of estimation with Table 1 and Fig. 7 can be explained as follows:

- Delay time :  $IV < III \leq II < I$
- Performance capability :  $IV > III \geq II > I$

## 5 Conclusion

Ubiquitous computing is considered as the next generation computing paradigm. Many sensors will be able to provide various and abundant situation information in the ubiquitous computing environment. Such a change of computing paradigm and development of technologies will require more extensive and far-reaching usability than the current RFID systems. Currently, the functions of the current RFID system are limited only to identification and recognition of objects. Thus, the systems provide the functions for simply reading and processing ID information in little consideration of situations.

In case that information on a RFID tag is used only within a specific time or at a specific place, current RFID system architecture does not consider such a use policy at all. To support this application, it is sometimes needed to receive information from sensors detecting location information and to determine availability of an object identified from the tag at a specific time. Valid geographic location information should be received from the sensor for the access permission.

Therefore, a new extended RFID system architecture should be defined for determining and utilizing various use policies for the RFID system based on information acquired from the diverse sensors. The definition of the extended RFID system architecture requires methods to interpret and define the situation information, and also needs to consider how to manage the information from the various sensors.

In this paper, we proposed the use policies and a formal language for the expression of the use policies to support the SA concept in the ubiquitous computing environ-

ment, suggested several types of SA-RFID system architecture. Finally, we qualitatively compared and evaluated the system architectures.

Our system architectures may be selectively utilized as need. It is expected that our architectures overcome simple and restrained functions of the existing RFID system and provide far-reaching applications. Above all, it is feasible to utilize the various RFID tags based on the situation information and determine the diverse access methods.

Further researches are demanded on implementation technologies of optimum inference engines. Especially, the compactness of the inference engines allows the definition on more diverse system architectures beyond our system architectures.

## Acknowledgement

Hoh Peter In and Dongwon Jeong are the corresponding authors.

## References

1. K. Finkenzeller, "RFID Handbook: Radio-Frequency Identification Fundamentals and Applications," John Wiley & Sons, (2000)
2. S. E. Sarma, S. A. Weis, D. W. Engels, "RFID Systems and Security and Privacy Implications," Lecture Notes in Computer Science, In Workshop on Cryptographic Hardware and Embedded Systems, LNCS 2523, February (2002) 454-470
3. S. Yau, F. Karim, Y. Wang, B. Wang, and S. Gupata, "Reconfigurable Context-Sensitive Middleware for Pervasive Computing," IEEE Pervasive Computing, Vol. 1, No. 3, September (2002) 33-40
4. S. S. Yau and F. Karim, "Adaptive Middleware for Ubiquitous Computing Environments," Proc. IFIP 17th WCC, August (2002)
5. S. Yau, Y. Wang, and F. Karim, "Developing Situation-Awareness in Middleware for Ubicomp Environments," Proc. 26th Int'l Computer Software and Applications Conference (2002) 233-238
6. P. J. Daugherty, T. P. Stank, and D. S. Rogers, "Third-Party Logistics Service Providers: Purchasers' Perceptions," The Journal of Supply Chain Management, Vol. 32, No. 2 (1996) 23-29
7. Association for Automatic Identification and Mobility (AIM), <http://www.aimglobal.org/>
8. H. Wang, M. K. O. Lee, and C. Wang, "Consumer Privacy Concerns about Internet Marketing," Communication of the ACM, Vol.41, No.3 (1998) 63-70
9. D. Jeong, Y.-G. Kim, and H. P. In, "New RFID System Architectures Supporting Situation Awareness under Ubiquitous Environments," Science Publications, Journal of Computer Science, Vol. 1, No. 2 (2005) 114-120
10. J. J. Chen and C. Adams, "Short-range Wireless Technologies with Mobile Payments Systems," ACM Press, Sixth International Conference on Electronic Commerce (ICEC'04), Delft, The Netherlands, October (2004) 649-656
11. Intermec, "IP3 Portable RFID(UHF) Reader," (2005), [http://www.intermec.com/eprise/main/Intermec/Content/Products/Products\\_ShowDetail?Product=RFID2\\_IP3#](http://www.intermec.com/eprise/main/Intermec/Content/Products/Products_ShowDetail?Product=RFID2_IP3#)
12. Object Management Group (OMG), "UML Specifications 2.0," October (2004)
13. H. P. In, C. Kim, and S. S. Yau, "Q-MAR: An Adaptive QoS Management Model for Situation-Aware Middleware," EUC2004, Aizu-Wakamatsu City, Japan, August (2004) 972-981